

# INTER LOCKING PAVING

## UNI

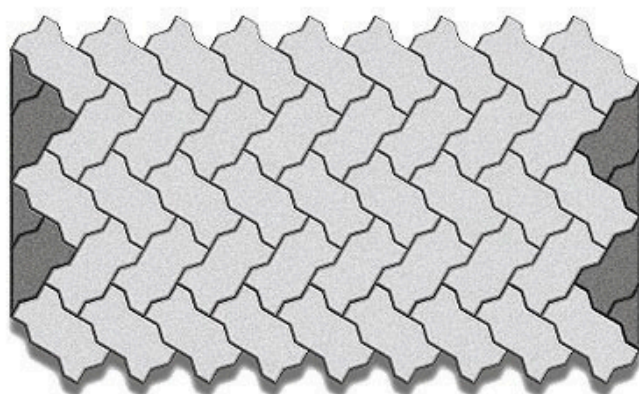
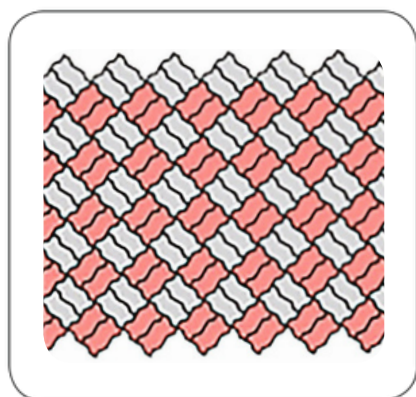
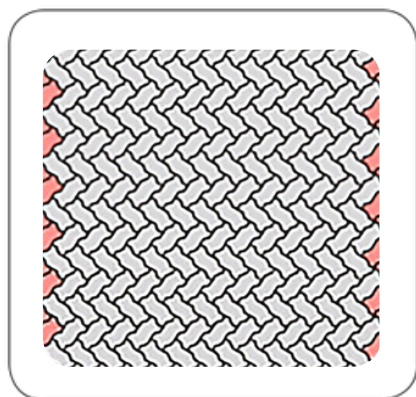

### Format

- 11.25 x 22.5 x 6 cm
- 11.25 x 22.5 x 8 cm
- 11.25 x 22.5 x 10 cm

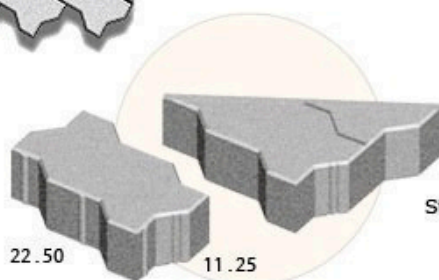
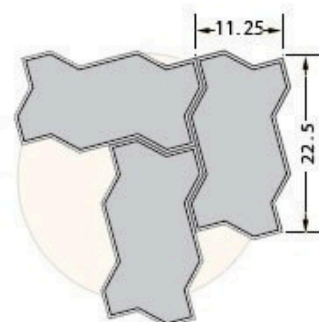

Standard Uni Block pavings are manufactured in 6, 8 and 10 cm thickness

■ Colours available

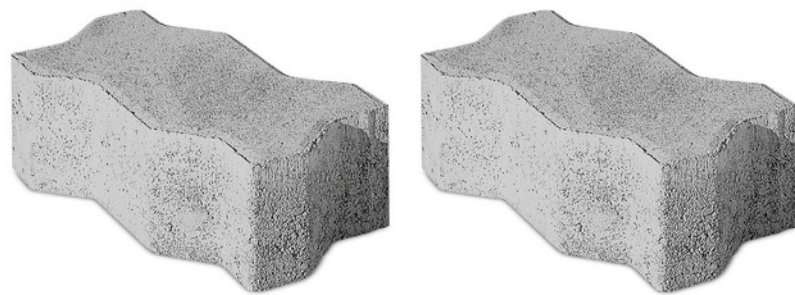

### Technical details

Size	22.5x11.25	22.5x11.25
Thickness of Stone (cm)	8	6
Area per Stone(cm <sup>2</sup> )	253.125	253.125
Stones/m <sup>2</sup>	39.5	39.5
Weight Kg/m <sup>2</sup>	188	141
m <sup>2</sup> /Layer	1.265	1.265
m <sup>2</sup> /Bundle (8 Layer)	10.12	12.65
m <sup>2</sup> /Trailer (24 Bundles)	242.88	303.6

# PRODUCTS

## UNI BLOCK

PAGE NO. 12-13

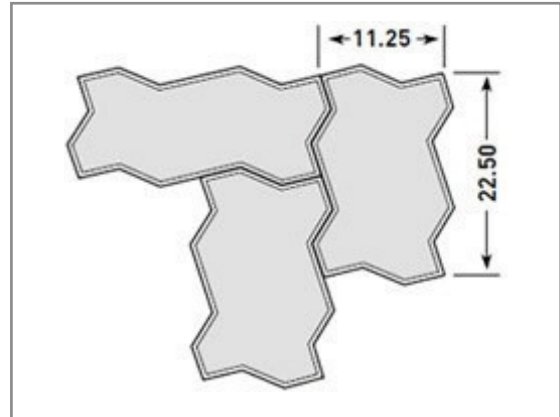

## RECTANGULAR BLOCK

PAGE NO. 14-15

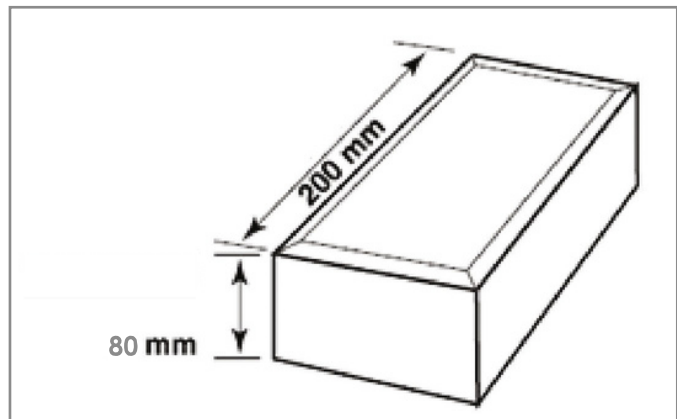

## VARIO BLOCK

PAGE NO. 16-17

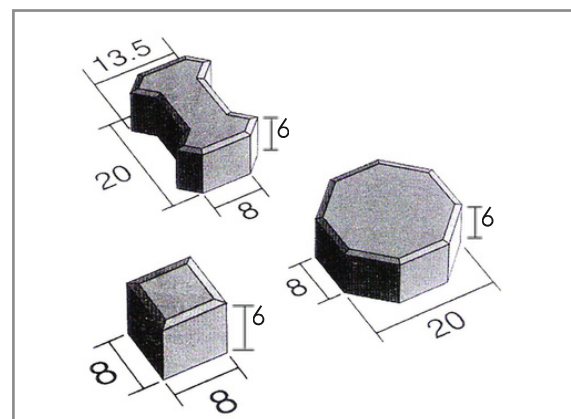

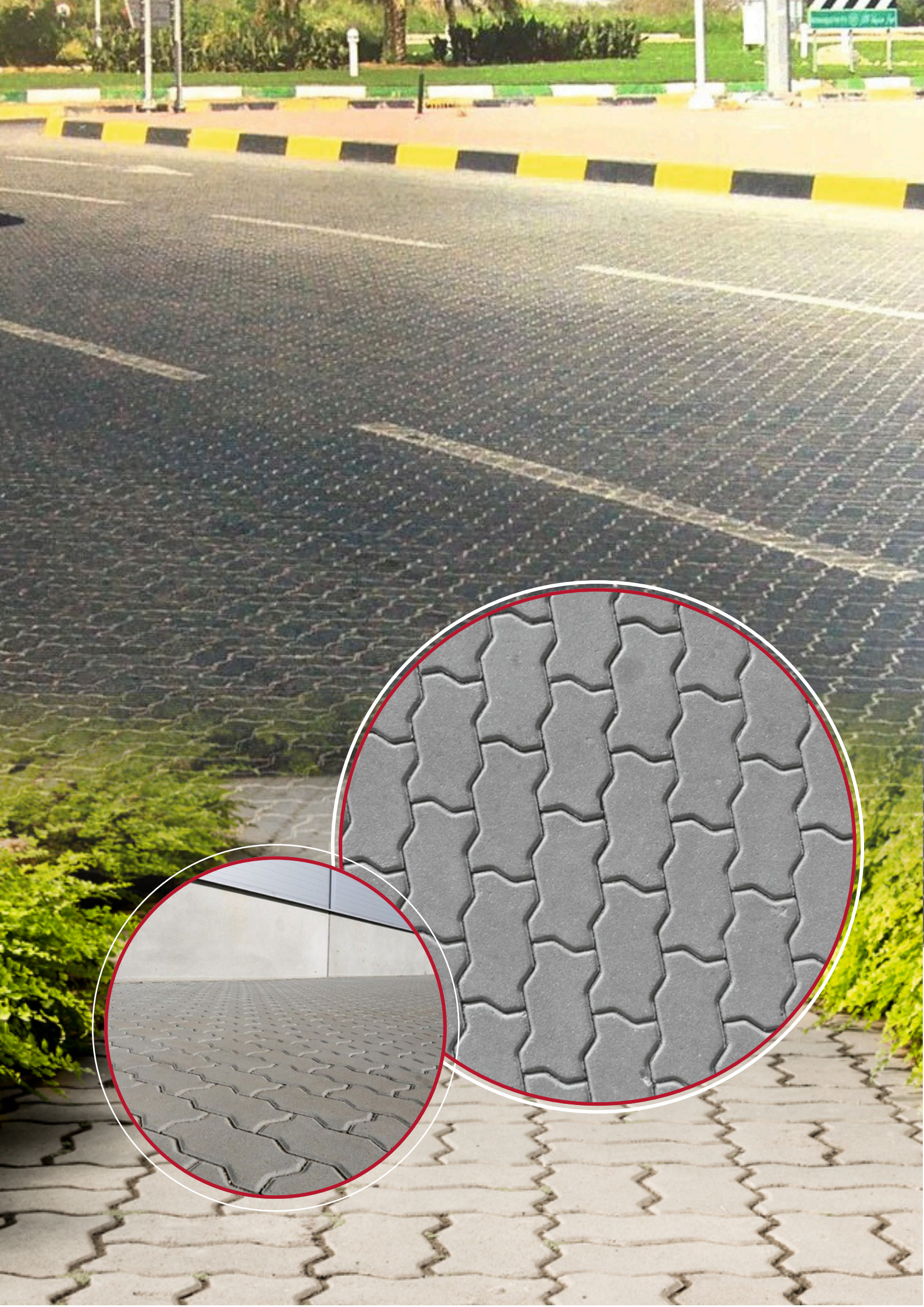

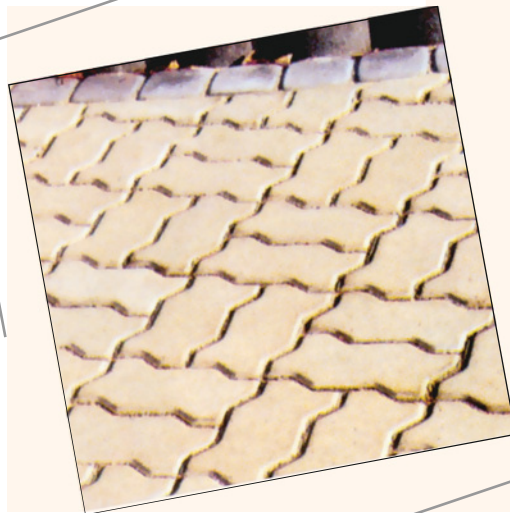
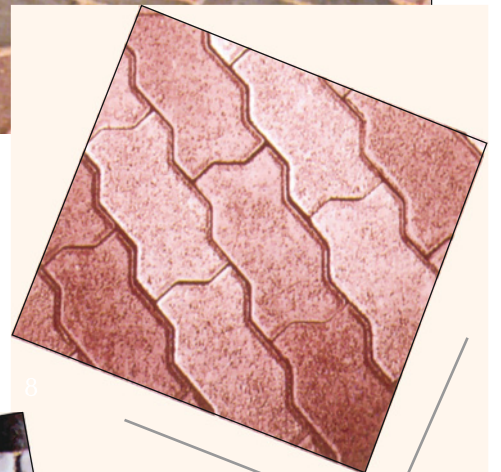
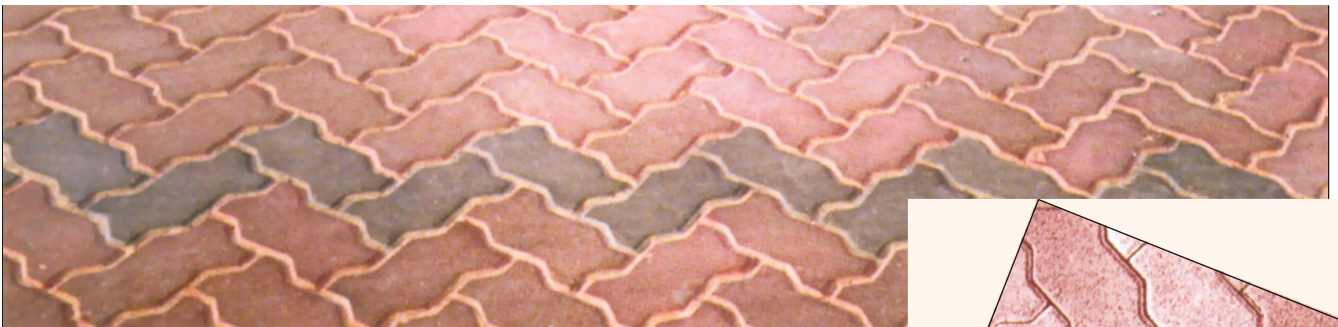
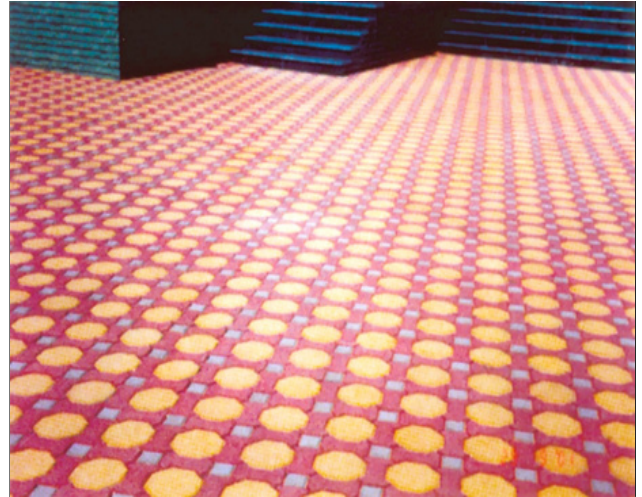
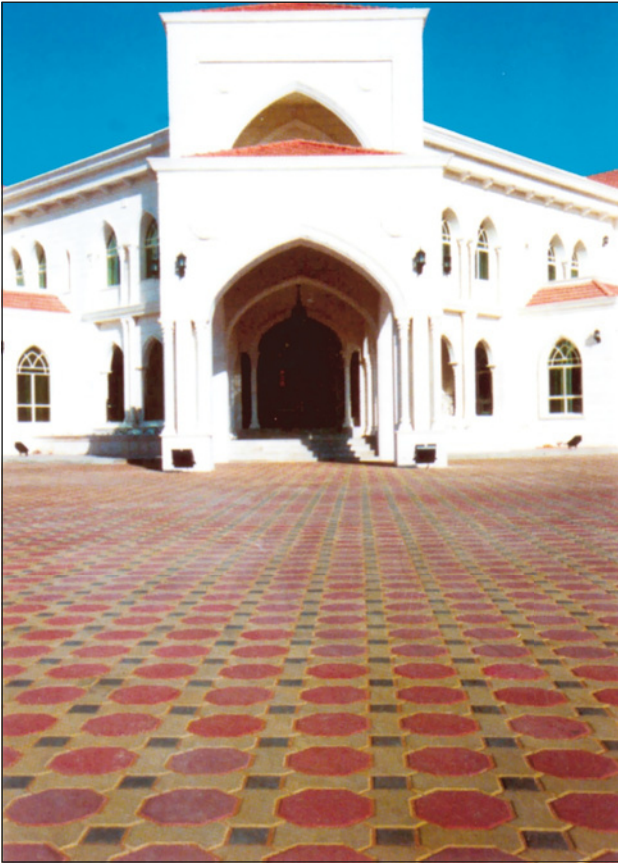

8